

## Subminiature Basic Switch

## SS

### Economical, Subminiature Basic Switch Offers Long Life (30 x 10<sup>6</sup> Operations)

- Incorporating simple and stable two split springs which ensures a long service life (30,000,000 operations).
- A variety of models with low operating force to high operating force are available.
- Solder, quick-connect terminals (#110) and PCB terminals are available.
- Approval obtained for standards including UL, CSA, and VDE.
- Conforms to EN61058-1.

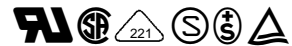

## Ordering Information

### ■ Model Number Legend

SS-□□□□□  
 1 2 3 4 5

#### 1. Ratings

01: 0.1 A  
 5: 5 A  
 10: 10 A

#### 2. Actuator

None: Pin plunger  
 GL: Hinge lever  
 GL13: Simulated hinge lever  
 GL2: Hinge roller lever

#### 3. Operating Force (at Pin Plunger)

None: 1.47 N {150 gf}  
 -F: 0.49 N {50 gf}  
 -E: 0.25 N {25 gf}

**Note:** These values are for the pin plunger model.

#### 4. Contact Form

None: SPDT  
 -2: SPST-NC  
 -3: SPST-NO













#### 5. Terminals

None: Solder  
 T: Quick-connect terminals (#110)  
 D: PCB

**Note:** The PCB terminal has a right-angle terminal option.  
 D1: Upward direction  
 D2: Downward direction  
 These are UL, CSA, and VDE approved.

**Note:** When suffix "-T" is placed after the model number, the model withstands high temperatures (-25°C to 125°C) and is UL and CSA approved.

## ■ List of Models

Rating	Actuator	OF max.	Soldering terminal	Quick-connect terminal (#110)	PCB terminal	
0.1 A	Pin plunger 	0.25 N {25 gf}	SS-01-E	SS-01-ET	SS-01-ED	
		0.49 N {50 gf}	SS-01-F	SS-01-FT	SS-01-FD	
		1.47 N {150 gf}	SS-01	SS-01T	SS-01D	
	Hinge lever 	0.08 N {8 gf}	SS-01GL-E	SS-01GL-ET	SS-01GL-ED	
		0.16 N {16 gf}	SS-01GL-F	SS-01GL-FT	SS-01GL-FD	
		0.49 N {50 gf}	SS-01GL	SS-01GLT	SS-01GLD	
	Simulated hinge lever 	0.08 N {8 gf}	SS-01GL13-E	SS-01GL13-ET	SS-01GL13-ED	
		0.16 N {16 gf}	SS-01GL13-F	SS-01GL13-FT	SS-01GL13-FD	
		0.49 N {50 gf}	SS-01GL13	SS-01GL13T	SS-01GL13D	
	Hinge roller lever 	0.08 N {8 gf}	SS-01GL2-E	SS-01GL2-ET	SS-01GL2-ED	
		0.16 N {16 gf}	SS-01GL2-F	SS-01GL2-FT	SS-01GL2-FD	
		0.49 N {50 gf}	SS-01GL2	SS-01GL2T	SS-01GL2D	
5 A (see note 1)	Pin plunger 	0.49 N {50 gf}	SS-5-F	SS-5-FT	SS-5-FD	
		1.47 N {150 gf}	SS-5	SS-5T	SS-5D	
	Hinge lever 	0.16 N {16 gf}	SS-5GL-F	SS-5GL-FT	SS-5GL-FD	
		0.49 N {50 gf}	SS-5GL	SS-5GLT	SS-5GLD	
	Simulated hinge lever 	0.16 N {16 gf}	SS-5GL13-F	SS-5GL13-FT	SS-5GL13-FD	
		0.49 N {50 gf}	SS-5GL13	SS-5GL13T	SS-5GL13D	
	Hinge roller lever 	0.16 N {16 gf}	SS-5GL2-F	SS-5GL2-FT	SS-5GL2-FD	
		0.49 N {50 gf}	SS-5GL2	SS-5GL2T	SS-5GL2D	
	10.1 A (see note 1)	Pin plunger 	1.47 N {150 gf}	SS-10	SS-10T	SS-10D
		Hinge lever 	0.49 N {50 gf}	SS-10GL	SS-10GLT	SS-10GLD
Simulated hinge lever 		0.49 N {50 gf}	SS-10GL13	SS-10GL13T	SS-10GL13D	
Hinge roller lever 		0.49 N {50 gf}	SS-10GL2	SS-10GL2T	SS-10GL2D	

**Note:** 1. EN61058-1 (IEC601058-1) approved by TÜV Rheinland.  
2. SPST models are also available, but not listed in the above table.

# Specifications

## ■ Ratings

Type	Rated voltage	SS-10, SS-5								SS-01	
		Non-inductive load				Inductive load				Non-inductive load	
		Resistive load		Lamp load		Inductive load		Motor load		Resistive load	
		NC	NO	NC	NO	NC	NO	NC	NO	NC	NO
General-purpose	125 VAC	5 (10.1) A (see note 1)		1.5 A	0.7 A	3 A		2.5 A	1.3 A	0.1 A	
	250 VAC	3 (10.1) A (see note 1)		1 A	0.5 A	2 A		1.5 A	0.8 A	---	
	8 VDC	5 (10.1) A (see note 1)		2 A		5 A	4 A	3 A		0.1 A	
	14 VDC	5 (10.1) A (see note 1)		2 A		4 A	4 A	3 A		0.1 A	
	30 VDC	4 A		2 A		3 A	3 A	3 A		0.1 A	
	125 VDC	0.4 A		0.05 A		0.4 A	0.4 A	0.05 A		---	
	250 VDC	0.2 A		0.03 A		0.2 A	0.2 A	0.03 A		---	

- Note:**
1. Data in parentheses apply to the SS-10 models only.
  2. The above values are for the steady-state current.
  3. Inductive load has a power factor of 0.4 min. (AC) and a time constant of 7 ms max. (DC).
  4. Lamp load has an inrush current of 10 times the steady-state current.
  5. Motor load has an inrush current of 6 times the steady-state current.
  6. If the Switch is used in a DC circuit and is subjected to a surge, connect a surge suppressor across the Switch.
  7. The ratings values apply under the following test conditions:  
 Ambient temperature:  $20 \pm 2^\circ\text{C}$   
 Ambient humidity:  $65 \pm 5\%$   
 Operating frequency: 30 operations/min

Use the Switch within the following operating range.

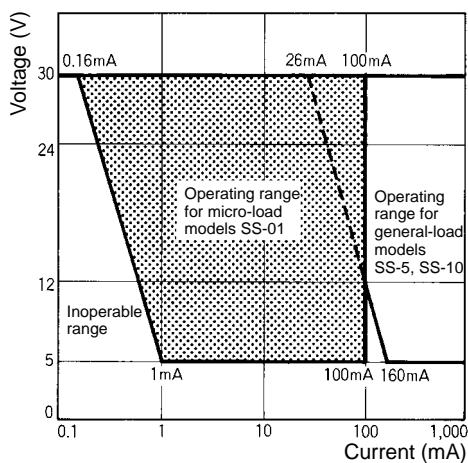

Item	SS-01	SS-5 SS-10
Minimum applicable load	1 mA at 5 VDC	160 mA at 5 VDC

## ■ Characteristics

<b>Operating speed</b>	0.1 mm to 1 m/s (pin plunger models)
<b>Operating frequency</b>	Mechanical: 400 operations/min Electrical: 60 operations/min
<b>Insulation resistance</b>	100 MΩ min. (at 500 VDC)
<b>Contact resistance (initial value)</b>	OF 1.47 N {150 gf}: SS-01 models: 50 mΩ max. SS-5, SS-10 models: 30 mΩ max. OF 0.49 N {50 gf}: SS-01 models: 100 mΩ max. SS-5 models: 50 mΩ max. OF 0.25 N {25 gf}: SS-01 models: 150 mΩ max.
<b>Dielectric strength</b>	1,000 VAC (600 VAC for SS-01 models), 50/60 Hz for 1 min between terminals of the same polarities 1,500 VAC, 50/60 Hz for 1 min between current-carrying metal part and ground, and between each terminal and non-current-carrying metal part (see note 1)
<b>Vibration resistance (see note 2)</b>	Malfunction: 10 to 55 Hz, 1.5-mm double amplitude
<b>Shock resistance</b>	Destruction: OF 1.47 N {150 gf}: 1,000 m/s <sup>2</sup> {approx. 100G} max. OF 0.25 N {25gf}/0.49 N {50 gf}: 500 m/s <sup>2</sup> {approx. 50G} max. Malfunction: OF 1.47 N {150 gf}: 300 m/s <sup>2</sup> {approx. 30G} max. OF 0.25 N {25 gf}/0.49 N {50 gf}: 200 m/s <sup>2</sup> {approx. 20G} max. <b>Note:</b> Lever-type model: Total travel position (with a contact separation time of 1 ms max.)
<b>Life expectancy</b>	Mechanical: 30,000,000 operations min. (Refer to the following <i>Engineering Data</i> ) 10,000,000 operations min. for SS-10 models Electrical: 200,000 operations min. (Refer to the following <i>Engineering Data</i> ) 50,000 operations min. for SS-10 models
<b>Degree of protection</b>	IP00
<b>Degree of protection against electrical shock</b>	Class 1
<b>Proof Tracking Index (PTI)</b>	175
<b>Switch category</b>	D (IEC 335-1)
<b>Ambient temperature</b>	Operating: -25°C to 85°C (at ambient humidity of 60% max.) (with no icing)
<b>Ambient humidity</b>	Operating: 85% max. (for 5°C to 35°C)
<b>Weight</b>	Approx. 1.6 g (pin plunger models)

- Note:** 1. The dielectric strength shown in the table indicates a value for models with a Separator.  
2. For the pin plunger models, the above values apply for use at both the free position and total travel position. For the lever models, they apply at the total travel position.

## ■ Approved Standards

**UL1054 (File No. E41515)**

**CSA C22.2 No. 55 (File No. LR21642)**

Rated voltage	SS-10	SS-5	SS-01
125 VAC	---	5 A	0.1 A
250 VAC	10.1 A	3 A	---
30 VDC	---	---	0.1 A
120 VAC (TV)	---	2 A	---

**VDE0630 (File No. 6131ÜG)**

**SEMKO (File No. 9812216/01), (File No. 8916091)**

Rated voltage	SS-10	SS-5
250 VAC	10 A	5 A

**SEV (File No. 93. 5. 51936. 01)**

Rated voltage	SS-5
250 VAC	5 A

**EN61058-1 (IEC601058-1)**

**(TÜV Rheinland, File No. J9451450)**

Rated voltage	SS-10	SS-5	SS-01
250 VAC	10 A	5 A 5 (1) A motor 3 A (see note 2)	---
125 VAC	---	---	0.1 A (see note 2)
30 VDC	---	5 A (see note 2)	0.1 A (see note 2)

- Note:** 1. Testing conditions: 50,000 operations, T85 (0°C to 85°C)  
2. These approvals are only limited to OF 1.47 N {150 gf} models.

■ Contact Specifications

Item		SS-10	SS-5	SS-01
Contact	Specification	Rivet		Crossbar
	Material	Silver alloy	Silver	Gold alloy
	Gap (standard value)	0.5 mm		0.25 mm
Inrush current	NC	20 A max.		1 A max.
	NO	15 A max.	10 A max.	1 A max.

■ Contact Form (SPDT)

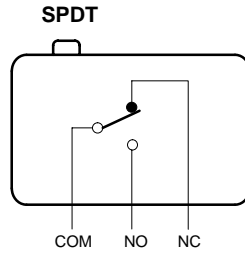

Engineering Data

Mechanical Life Expectancy (Pin Plunger Model)

SS-5, SS-1, SS-01 Models

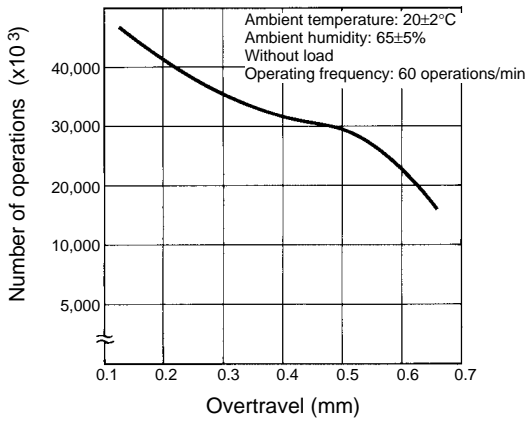

Electrical Life Expectancy (Pin Plunger Model)

SS-5 Models

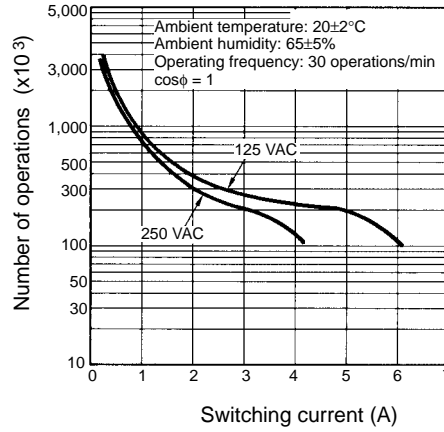

Dimensions

■ Terminals

Terminal plate thickness is 0.5 mm.

Solder Terminal

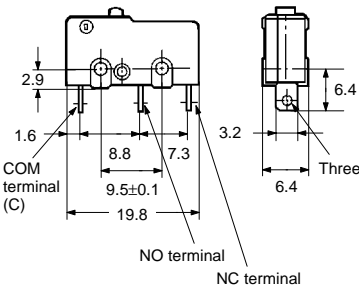

Quick-connect Terminal (#110)

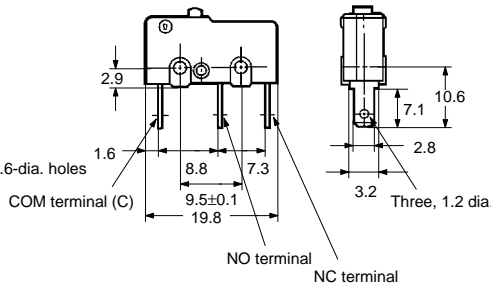

PCB Terminal

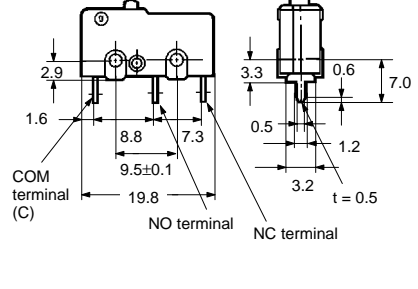

## ■ Dimensions and Operating Characteristics

**Note:** 1. All units are in millimeters unless otherwise indicated.

2. The following illustration and drawing are for solder terminal models. Refer to page 118 for details on models with quick-connect terminals (#110) or PCB terminals.

3. Unless otherwise specified, a tolerance of  $\pm 0.4$  mm applies to all dimensions.

### Pin Plunger

SS-01(-E, -F)

SS-5(-F)

SS-10

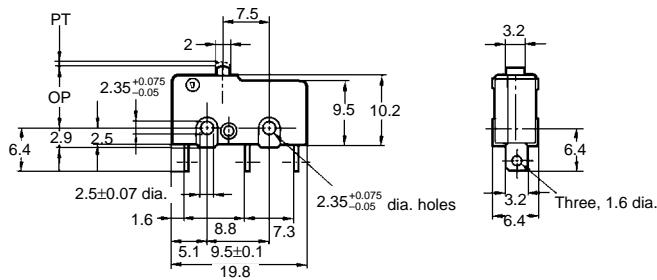
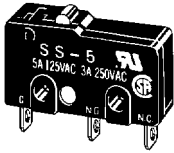

Model	SS-01-E	SS-01-F SS-5-F	SS-01 SS-5	SS-10
OF max.	0.25 N {25 gf}	0.49 N {50 gf}	1.47 N {150 gf}	1.47 N {150 gf}
RF min.	0.02 N {2 gf}	0.04 N {4 gf}	0.25 N {25 gf}	0.25 N {25 gf}
PT max.	0.5 mm	0.5 mm	0.5 mm	0.6 mm
OT min.	0.5 mm	0.5 mm	0.5 mm	0.4 mm
MD max.	0.1 mm	0.1 mm	0.1 mm	0.12 mm
OP	8.4±0.5 mm			

### Hinge Lever

SS-01GL(-E, -F)

SS-5GL(-F)

SS-10GL

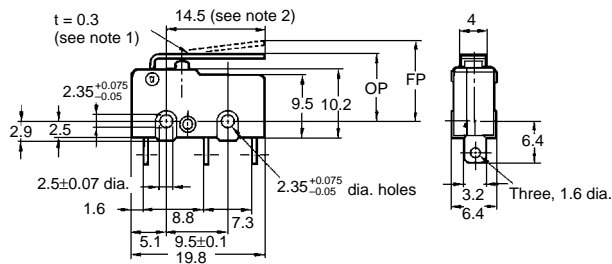
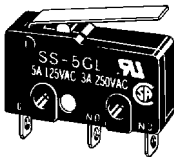

**Note:** 1. Stainless-steel lever

2. Besides the SS-□GL models with a hinge lever length of 14.5, the SS-□GL11 models with a hinge lever length of 18.5, the SS-□GL111 models with a hinge lever length of 22.6, and the SS-□GL1111 models with a hinge lever length of 37.8 are available. Contact your OMRON representative for these models

Model	SS-01GL-E	SS-01GL-F SS-5GL-F	SS-01GL SS-5GL	SS-10GL
OF max.	0.08 N {8 gf}	0.16 N {16 gf}	0.49 N {50 gf}	0.49 N {50 gf}
RF min.	0.01 N {1 gf}	0.02 N {2 gf}	0.06 N {6 gf}	0.06 N {6 gf}
OT min.	1.2 mm	1.2 mm	1.2 mm	1.0 mm
MD max.	0.8 mm	0.8 mm	0.8 mm	1.0 mm
FP max.	13.6 mm			
OP	8.8±0.8 mm			

**Simulated Hinge Lever**

SS-01GL13(-E, -F)  
SS-5GL13(-F)  
SS-10GL13

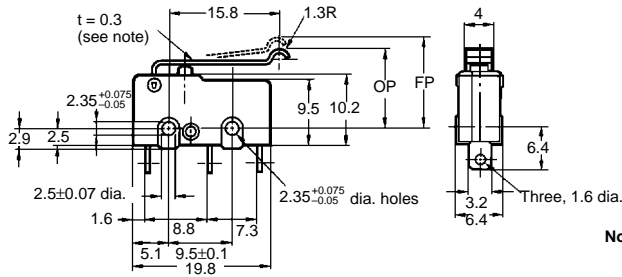
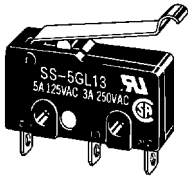

Note: Stainless-steel spring lever

Model	SS-01GL13-E	SS-01GL13-F SS-5GL13-F	SS-01GL13 SS-5GL13	SS-10GL13
OF max.	0.08 N {8 gf}	0.16 N {16 gf}	0.49 N {50 gf}	0.49 N {50 gf}
RF min.	0.01 N {1 gf}	0.02 N {2 gf}	0.06 N {6 gf}	0.06 N {6 gf}
OT min.	1.2 mm	1.2 mm	1.2 mm	1.0 mm
MD max.	0.8 mm	0.8 mm	0.8 mm	1.0 mm
FP max.	15.5 mm			
OP	10.7±0.8 mm			

**Hinge Roller Lever**

SS-01GL2(-E, -F)  
SS-5GL2(-F)  
SS-10GL2

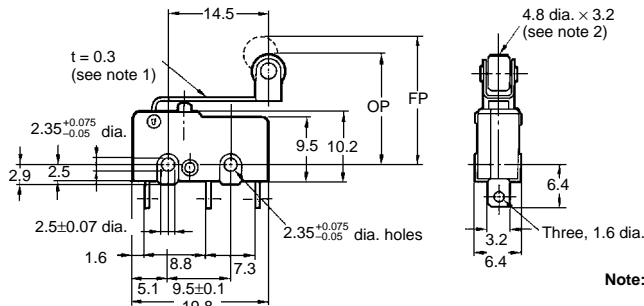
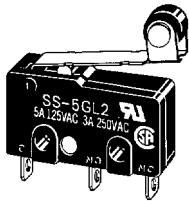

Note: 1. Stainless-steel spring lever  
2. Polyacetal resin roller

Model	SS-01GL2-E	SS-01GL2-F SS-5GL2-F	SS-01GL2 SS-5GL2	SS-10GL2
OF max.	0.08 N {8 gf}	0.16 N {16 gf}	0.49 N {50 gf}	0.49 N {50 gf}
RF min.	0.01 N {1 gf}	0.02 N {2 gf}	0.06 N {6 gf}	0.06 N {6 gf}
OT min.	1.2 mm	1.2 mm	1.2 mm	1.0 mm
MD max.	0.8 mm	0.8 mm	0.8 mm	1.0 mm
FP max.	19.3 mm			
OP	14.5±0.8 mm			

■ Separators (Insulation Sheet)

Applicable Switch	Thickness (mm)	Model (see note)
SS, D2S, D2SW	0.18	Separator for SS0.18
	0.4	Separator for SS0.4

Separator for SS□

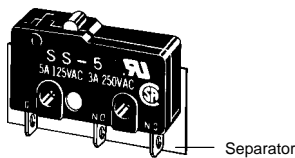

## Precautions

### ■ Mounting

Use two M2.3 mounting screws with spring washers to mount the Switch. Tighten the screws to a torque of 0.23 to 0.26 N • m {2.3 to 2.6 kgf • cm}.

#### Mounting Holes

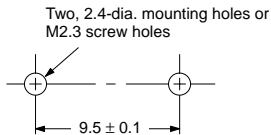

#### PCB Mounting Dimensions (Reference)

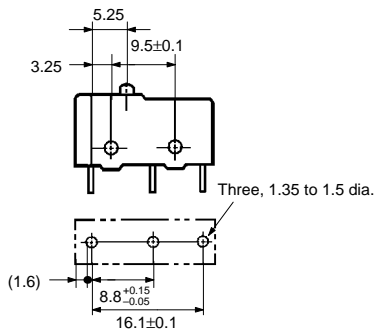

### ■ Correct Use

Refer to pages 22 to 29 for common precautions.

### Terminal Connection

When soldering the lead wire to the terminal, first insert the lead wire conductor through the terminal hole and then conduct soldering.

To solder the lead to the terminal, apply a soldering iron rated at 60 W max. (temperature of soldering iron: 250°C to 300°C) within 5 seconds. During soldering and one minute after soldering, do not apply any external force to the soldered terminal.

Feed solder away from the switch case so that solder or flux will not flow into the case side.

If the PCB terminal models are soldered in the solder bath, flux will permeate inside the Switch and cause contact failure. Therefore, manually solder the PCB terminal.

#### Specifications Approved by TÜV Rheinland According to EN61058-1

Model	Conductor size
SS-5	0.5 to 0.75 mm <sup>2</sup>
SS-10	0.75 mm <sup>2</sup>

#### Solder Terminal Approved Conditions

Soldering iron can be used. Soldering hook hole available.
Soldering terminal types 1 and 2 are met.

### Spacing

The minimum thickness of insulation according to IEC61058-1 is 1.1 mm, and the minimum clearance between live terminals and mounting plate is 1.6 mm. If the proper insulation for the terminator cannot be obtained, add insulation such as a Separator or insulation guard on the switch.

### ■ Connector

Refer to Terminal Connectors on page 214.

**ALL DIMENSIONS SHOWN ARE IN MILLIMETERS.**

To convert millimeters into inches, multiply by 0.03937. To convert grams into ounces, multiply by 0.03527.